

Ausrack TxD

Multipurpose cabinets and frames



- Designed for transmission and data applications in telecommunications exchange and data centre environments.
- 4-post rack suitable for 19", 21", 23" and 26" equipment.
- Open welded and bolted construction with corner posts.
- Load ratings tested to AS62208-2006.
- Allows for maximum flexibility in placement of equipment rails and cable management.
- Easy to bay with or without side panels.
- Manufactured from zinc coated steel:
Frame – 1.6mm, Rail – 2.0mm & Panels 1.2mm
- Powdercoated textured Matt Black.

Server Cabinet products come standard with:

- Frame and 2 x removable side panels
- 4 x 19" RU marked adjustable mounting rails
- Top cover with cable entries
- Mesh doors (600mmW cabinets)
- Split mesh doors (800mmW cabinets)
- 2 point door locking
- 4 x bolt down brackets



ORDERING GUIDE

Product	Part Number	RU	Dimensions (mm)			Bolt Down (mm)		Weight (kg)
			Height (A)	Width (B)	Depth (C)	Height (D)	Width (E)	
Server cabinet (Includes 4 x 19" rack rails, mesh doors, side panels)	ATS45U609 [▲]	45	2140	600	900	299	685	137.0
	ATS45U610 [▲]	45	2140	600	1000	299	785	144.0
	ATS45U612 [▲]	45	2140	600	1200	299	985	159.0
	ATS45U809 [▲]	45	2140	800	900	499	685	139.0
	ATS45U810 [▲]	45	2140	800	1000	499	785	148.0
	ATS45U812 [▲]	45	2140	800	1200	499	985	161.0
Standard frame (Includes 4 x 19" rack rails)	ATF45U609 [▲]	45	2140	600	900	299	685	77.0
	ATF45U610 [▲]	45	2140	600	1000	299	785	82.0
	ATF45U612 [▲]	45	2140	600	1200	299	985	96.0
	ATF45U809 [▲]	45	2140	800	900	499	685	80.0
	ATF45U810 [▲]	45	2140	800	1000	499	785	85.0
	ATF45U812 [▲]	45	2140	800	1200	499	985	99.0

[▲] Available on request

Ausrack TxD

Multipurpose cabinets and frames

TECHNICAL DRAWINGS

Server Cabinet

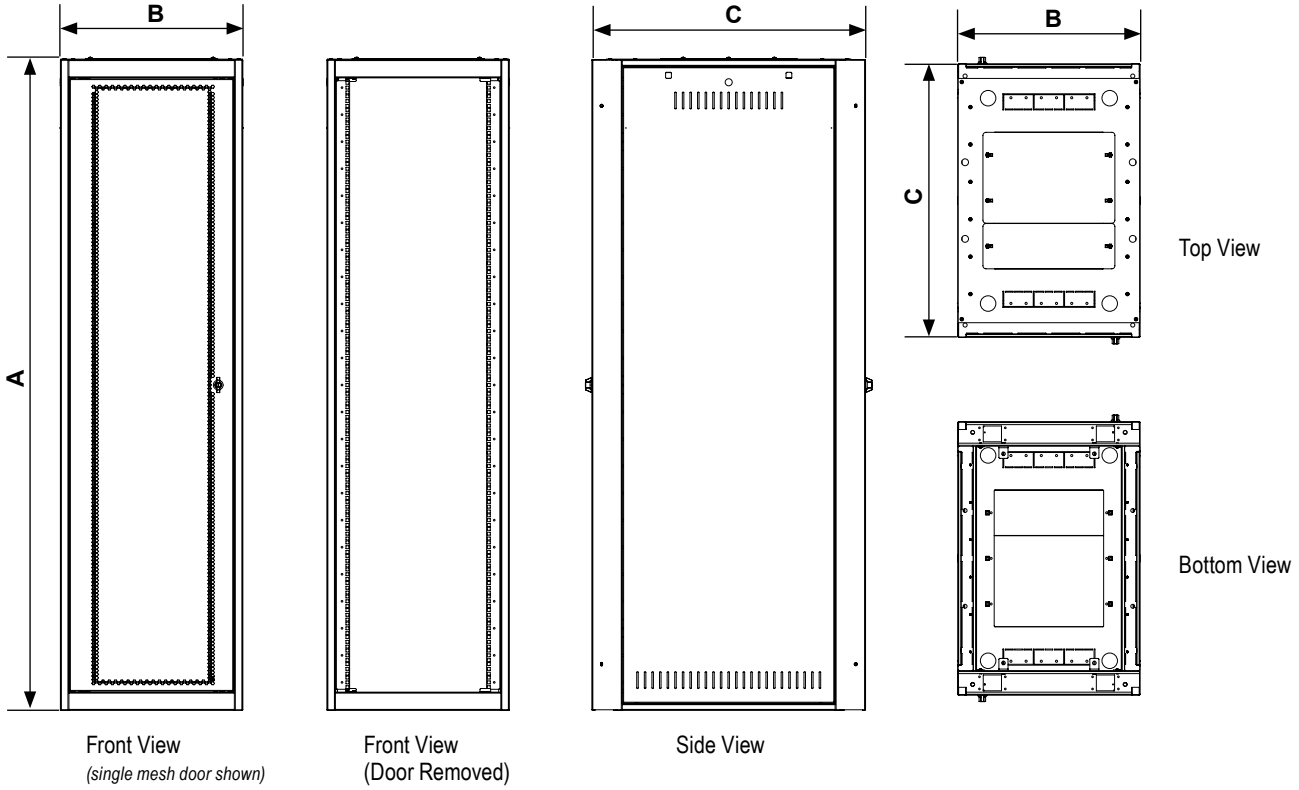

Standard Frame

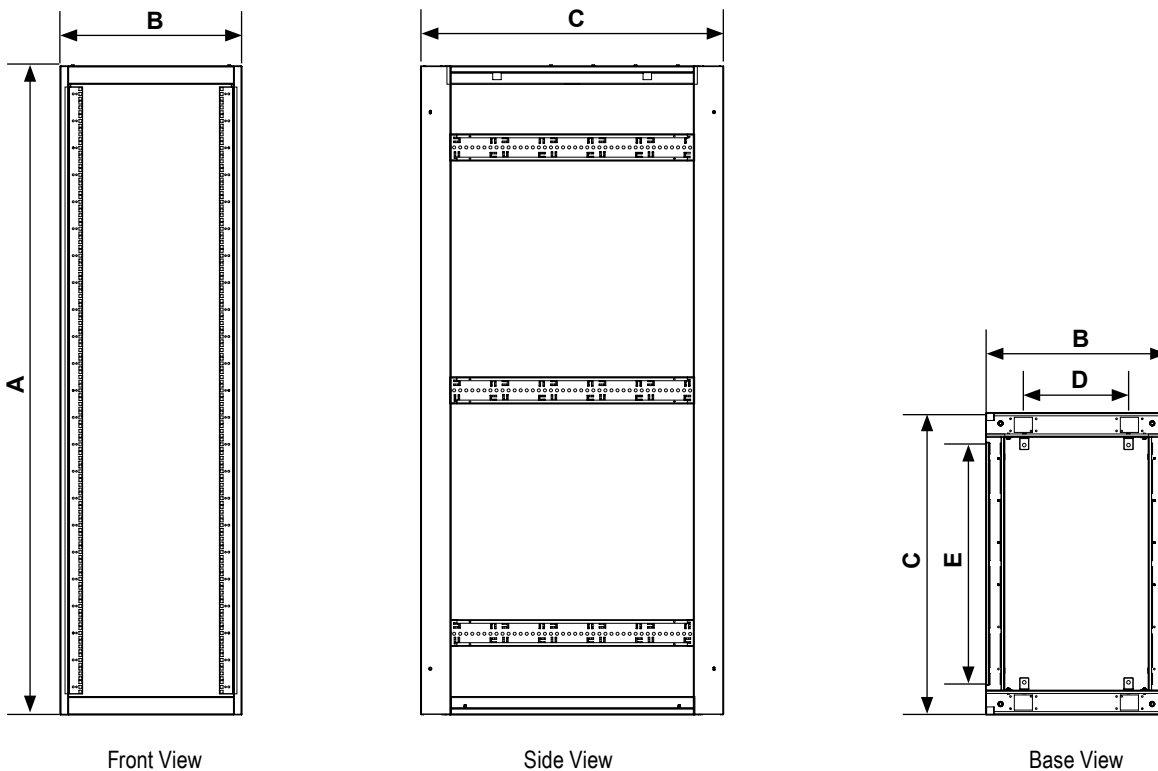

Data ICT Accessories

Accessories to suit all product ranges in this catalogue



Blanking Plates - for cable zones

Designed to seal the front section of racks bayed with cable zones from hot exhaust air at the rear of the cabinet. They extend between the posts of the two adjoining racks over the cable zone to the full height of the rack.

To suit cabinets & frames

Part Number	RU	Width (mm)	Product Range
ARBPB40U100▲	40RU	100	Ausrack cable zones
ARBPB40U200▲	40RU	200	
ARBPB45U100▲	45RU	100	
ARBPB45U200▲	45RU	200	

Cable zones available. Please see page 37.



ARPBP40U200

Blanking Panels - Eziblack

The adjustable tool-less blanking panels simply snap to the size you need and pushes onto the 19" mounting rails. The blanking panels can be easily snapped into 1RU increments to fit any gap. Made from UL94 fire rated and anti-static ABS plastic.

Part Number	Description	RU	To suit cabinets & frames
ARBP6U	Supplied as 6 x 1RU plastic panels	1	All B&R Data ICT cabinets and frames



ARBP6U

Blanking Panels - Metal

Used to control airflow within the rack. They are manufactured from 1.2mm steel with a powdercoated matt black surface finish.

Dimensions (mm)

Part Number	RU	Height (mm)	Width (mm)	To suit cabinets & frames
EBP1U	1	44	483	All B&R Data ICT cabinets and frames
EBP2U	2	88	483	
EBP3U	3	132	483	
EBP4U	4	177	483	
EBP5U▲	5	222	483	
EBP6U▲	6	266	483	



EBP

▲ Available on request

Data ICT Accessories

Accessories to suit all product ranges in this catalogue

Brush Strips - Ezibrush™

Keeps hot exhaust air away from cool intake air, extending the life of your equipment. These panels have a brush strip overhanging the 1RU size by an extra 5mm allowing simple management of air gaps when placed alongside other equipment.

Part Number	Description	RU	To suit cabinets & frames
ARBPB1U▲	Horizontal, 19" black, pack of 5 strips	1	All B&R Data ICT cabinets and frames



ARBPB1U

Brush Strips - Vertical

Designed to control airflow in the rack. They provide a barrier between the front of the frame and hot exhaust air at the rear, between the post and the side panel whilst also allowing cable access. Each strip attaches to the post and extends to the side panel of the cabinet. Sold as pairs (if ordering one (1) unit, it comes as two (2) strips).

For use with racks:

Part Number	To suit cabinets & frames		
	RU	Width (mm)	Product Range
ARPBS40U06▲	40	600	Ausrack Plus
ARPBS40U08▲	40	800	
ARPBS45U06▲	45	600	
ARPBS45U08▲	45	800	

For use with cable zones:

Part Number	To suit cabinets & frames		
	RU	Width (mm)	Product Range
ARPBS40U100▲	40	100mm wide	Ausrack Plus
ARPBS40U106▲	40	cable zones	
ARPBS40U200▲	40	200mm wide	
ARPBS40U206▲	40	cable zones	
ARPBS45U100▲	45	100mm wide	
ARPBS45U106▲	45	cable zones	
ARPBS45U200▲	45	200mm wide	
ARPBS45U206▲	45	cable zones	



ARPBS40U08

▲ Available on request

Data ICT Accessories

Accessories to suit all product ranges in this catalogue



Cable Management - Horizontal

Cable management is an efficient and tidy way to keep on top of high density cabling in a rack or cabinet. Horizontal options can be incorporated into any B&R rack or cabinet.

Part Number	RU	Width (mm)	Depth (mm)	Description	To suit cabinets & frames
-------------	----	------------	------------	-------------	---------------------------

Horizontal Cable Management

ARHCMF1U	1	480	125	Mounts on equipment rails 90mm finger length	All 19" racks
ARHCMF2U	2	480	125		
ARHCMF4U [▲]	4	480	125		



ARHCMF1U



ARHCMF2U



ARHCMF4U

Horizontal Cable Management Extended Finger / Cover Pane

ARHCMFX1U [▲]	1			Extended finger 150mm finger length	All 19" racks
ARHCMFX2U [▲]	2				
ARHCMFX4U [▲]	4				

Horizontal Cable Management Rings

ARCMHM1U120	1			Metal 120mm x 41.5mm ring	All 19" racks
ARCMHM2U120	2			Metal 120mm x 83mm ring	
ARPCMH1U	1			Plastic 55mm x 30mm ring	

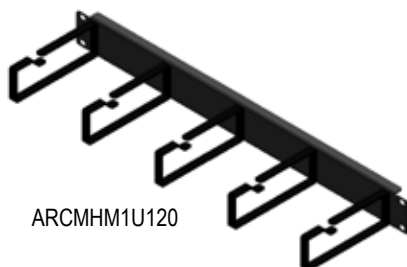
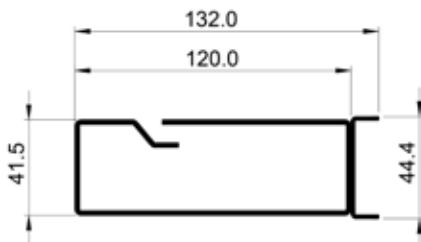

ARCMHM1U120

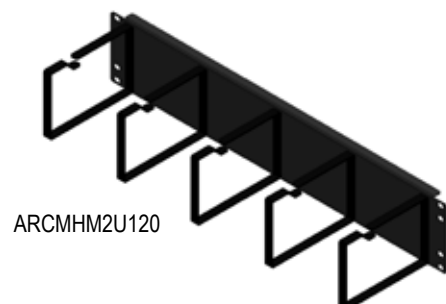
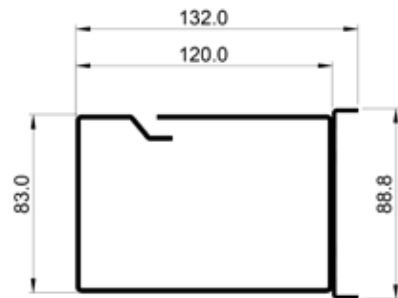

ARCMHM2U120

▲ Available on request

Data ICT Accessories

Accessories to suit all product ranges in this catalogue

Cable Management - Horizontal

Part Number	RU	Width (mm)	Depth (mm)	Description	To suit cabinets & frames
Cable Management Rings					
ARPCMR2S	–	161	96	Single zone	Ausrack Plus, CQr Guardian, TxD, Patch, IP, Field FE & iLINQ
ARPCMR3S [▲]	–	306	96	Single zone*	Ausrack Plus (excluding 600mm frame) & Patch
ARPCMR3D [▲]	–	306	250	Two zone*	
Cable Management Hanger					
ARPCMP24	–			24 patch lead hanger, 597mm	Stand alone product wall mount

* Requires Cable Zone



ARPCMR2S



ARPCMR3S

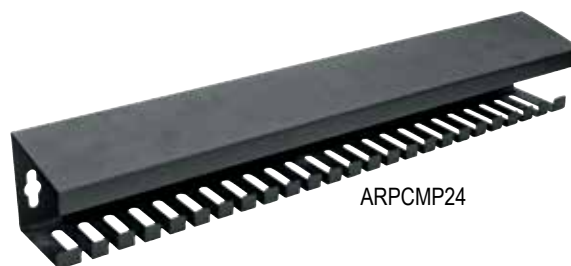

ARPCMP24

Horizontal Cable Capacity

	Cable Capacity						
	Cat5e	Cat6	Cat6e	Cat7	Fibre	Power 10A	Power 15A
Diameter (mm) [#]	5.6	6.3	8.4	7.6	3	7	8.5
Saturation*	50%	50%	50%	50%	60%	40%	40%
ARHCMF1U	31	25	14	17	129	16	11
ARHCMF2U	99	79	44	54	414	51	35
ARHCMF4U	227	179	101	123	947	116	79
ARPCMH2U	46	36	20	26	188	24	16
ARPCMR2S	205	162	92	112	858	105	72
ARPCMR3S	431	340	192	234	1799	221	150
ARPCMR3D	1167	922	519	634	4877	598	405

Please Note: B&R Enclosures does not accept liability for any errors within the above table.

[#] These are nominal values for the OD of cable as sizes may vary.

* Recommended maximum cable saturation.

▲ Available on request

Data ICT Accessories

Accessories to suit all product ranges in this catalogue



Cable Management - Vertical

Cable management is an efficient and tidy way to keep on top of high density cabling in a rack or cabinet. Horizontal options can be incorporated into any B&R rack or cabinet.

Part Number	RU	Width (mm)	Depth (mm)	Description	Mounting	To suit cabinets & frames (mm)	
Vertical Cable Management Fingers and Connection Bracket (90mm finger length)							
ARVCMF40U	40	15	180	2 sections (800mm + 889mm)	Outside of posts	Ausrack Plus	
ARVCMF45U	45	15	180	2 sections (2 x 978mm)	Outside of posts		
ARVCMF40UR▲	40	20.5	122	2 sections (800mm + 889mm)	On L-shape equipment rails	TxD, IP & iLINQ	
ARVCMF45UR	45	20.5	122	2 sections (2 x 978mm)	On L-shape equipment rails		
ARVCMF45U200	45	200	198	Cable zone required		Ausrack Plus	
Vertical Cable Management Extended Finger/ Cover Panel (150mm finger length)							
ARVCMFX40U▲	40	15	250	Extended Finger		Ausrack Plus	
ARVCMFX45U▲	45	15	250				
ARVCMFX40UR▲	40	20.5	250				TxD, IP & iLINQ
ARVCMFX45UR▲	45	20.2	250				



ARVCMF45U



ARVCMF45UR



ARVCMFX40UR

▲ Available on request

Data ICT Accessories

Accessories to suit all product ranges in this catalogue

Part Number	RU	Width (mm)	Depth (mm)	Description	Mounting	To suit cabinets & frames (mm)
Vertical Cable Management System						
ARVCMS40U10	40	100	165	Cable zone required* U-Channel system with cable fingers, connection brackets and cover flaps 90mm finger length	Off posts or Horizontal mounting rails	Ausrack Plus, TxD, Patch, IP & iLINQ
ARVCMS45U10	45	100	165			Ausrack Plus, TxD, Patch & iLINQ
ARVCMS40U20▲	40	200	165			Ausrack Plus & Patch
ARVCMS45U20▲	45	200	165			Ausrack Plus & Patch
ARVCMS40U150▲	40	150	198	Cable zone required* U-Channel system with cable fingers, connection brackets and cover flaps		Ausrack Plus & Patch
ARVCMS45U150▲	45	150	198			
ARVCMSX40U10▲	40	100	250	Cable zone required* Extended Finger 150mm finger length		Ausrack Plus, TxD, Patch & iLINQ
ARVCMSX45U10▲	45	100	250			
ARVCMSX40U20▲	40	200	250	Cable zone required* Extended Finger		Ausrack Plus & Patch
ARVCMSX45U20▲	45	200	250			



ARVCMS40U10



ARVCMSX40U20

*Cable Zone Requirements for Different Rack/Cabinet Widths

Cabinet Width (mm)	Width of Cable Management System (mm)	Cable Zone Width Required (mm)
600	100	100 or 200
600	150	200
600	200	200
800	100	100
800	150	100
800	200	100

Vertical Cable Capacity

	Cable Capacity						
	Cat5e	Cat6	Cat6e	Cat7	Fibre	Power 10A	Power 15A
Diameter (mm)#	5.6	6.3	8.4	7.6	3	7	8.5
Saturation*	50%	50%	50%	50%	60%	40%	40%
ARVCMSxxU10	269	213	120	146	1125	138	94
ARVCMSxxU20	597	472	266	324	2495	306	208

▲ Available on request

Data ICT Accessories

Accessories to suit all product ranges in this catalogue



Cable Trays

An effective way to keep vertical cable runs neat and tidy within a rack or cabinet.

Part Number	Cable Mounting Width (mm)	To suit cabinet RU	Height (mm)	To suit cabinets & frames
ARC18U15▲	150	18	702	
ARC18U30▲	300	18	702	
ARC18U45▲	450	18	702	
ARC24U15▲	150	24	969	
ARC24U30▲	300	24	969	
ARC27U15▲	150	27	1102	
ARC27U30▲	300	27	1102	
ARC27U45▲	450	27	1102	
ARC40U15▲	150	40	1680	Ausrack Plus, TxD, IP, Field FE & iLINQ
ARC40U30	300	40	1680	
ARC40U45▲	450	40	1680	
ARC42U15▲	150	42	1769	
ARC42U30▲	300	42	1769	
ARC42U45▲	450	42	1769	
ARC45U15	150	45	1902	
ARC45U30	300	45	1902	
ARC45U45▲	450	45	1902	



ARC18U15

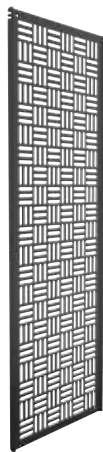

ARC24U30



ARC40U15



ARC45U45

▲ Available on request

Data ICT Accessories

Accessories to suit all product ranges in this catalogue

Cable Zone Kits

Designed for mounting onto the side of a cabinet, optimising accessibility and space available for cabling and cable management products. The kit consists of top and bottom plinths, front and rear cover panels (with standard latching) and all fixings required for installation onto the rack.

To suit cabinets & frames

Part Number	Width (mm)	RU	Depth (mm)	Product Range
AC40U06 [▲]	100	40	600	Ausrack Plus
AC40U09	100	40	900	
AC40U11 [▲]	100	40	1100	
AC45U06 [▲]	100	45	600	
AC45U08 [▲]	100	45	800	
AC45U09	100	45	900	
AC45U10 [▲]	100	45	1000	
AC45U11	100	45	1100	
AC45U12 [▲]	100	45	1200	
AC40U206 [▲]	200	40	600	
AC40U209 [▲]	200	40	900	
AC40U211 [▲]	200	40	1100	
AC45U206 [▲]	200	45	600	
AC45U209	200	45	900	
AC45U211	200	45	1100	
AC45U212 [▲]	200	45	1200	
AC47U212 [▲]	200	47	1200	

Cable zone blanking panels are available. Please see page 36.

200mm cable zone can be used in between bayed racks and cabinets



AC40U06



AC45U12



AC47U212

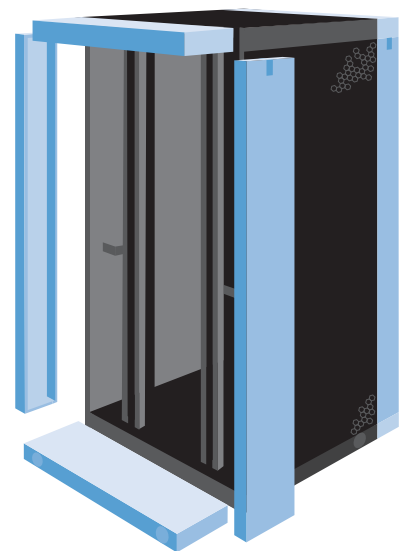

Illustration of Cable Zones added to a B&R rack.

▲ Available on request

Data ICT Accessories

Accessories to suit all product ranges in this catalogue



Cable Zone Bases & Cover Panels

Separate bases and cover panels are available to build-your-own cable zone kit. This allows for different latching options to be chosen for a cable zone

Bases

Part Number				To suit cabinets & frames
Standard	Hinged	Width (mm)	Depth (mm)	Product Range
ACBP106▲	ACBP106H▲	100	600	Ausrack Plus
ACBP108▲	ACBP108H▲	100	800	
ACBP109▲	ACBP109H▲	100	900	
ACBP110▲	ACBP110H▲	100	1000	
ACBP111▲	ACBP111H▲	100	1100	
ACBP112▲	ACBP112H▲	100	1200	
ACBP206▲	ACBP206H▲	200	600	
ACBP208▲	ACBP208H▲	200	800	
ACBP209▲	ACBP209H▲	200	900	
ACBP210▲	ACBP210H▲	200	1000	
ACBP211▲	ACBP211H▲	200	1100	
ACBP212▲	ACBP212H▲	200	1200	



ACBP106

Cover Panels

Part Number					To suit cabinets & frames
Standard	Hinged	External Latch	Internal Latch	RU	Product Range
ACCP18U10▲	ACCP18U10H▲	ACCP18U10EL▲	ACCP18U10IL▲	18	Ausrack Plus
ACCP18U20▲	ACCP18U20H▲	ACCP18U20EL▲	ACCP18U20IL▲	18	
ACCP24U10▲	ACCP24U10H▲	ACCP24U10EL▲	ACCP24U10IL▲	24	
ACCP24U20▲	ACCP24U20H▲	ACCP24U20EL▲	ACCP24U20IL▲	24	
ACCP27U10▲	ACCP27U10H▲	ACCP27U10EL▲	ACCP27U10IL▲	27	
ACCP27U20▲	ACCP27U20H▲	ACCP27U20EL▲	ACCP27U20IL▲	27	
ACCP40U10▲	ACCP40U10H▲	ACCP40U10EL▲	ACCP40U10IL▲	40	
ACCP40U20▲	ACCP40U20H▲	ACCP40U20EL▲	ACCP40U20IL▲	40	
ACCP42U10▲	ACCP42U10H▲	ACCP42U10EL▲	ACCP42U10IL▲	42	
ACCP42U20▲	ACCP42U20H▲	ACCP42U20EL▲	ACCP42U20IL▲	42	
ACCP45U10▲	ACCP45U10H▲	ACCP45U10EL▲	ACCP45U10IL▲	45	
ACCP45U20▲	ACCP45U20H▲	ACCP45U20EL▲	ACCP45U20IL▲	45	
ACCP47U10▲	ACCP47U10H▲	ACCP47U10EL▲	ACCP47U10IL▲	47	
ACCP47U20▲	ACCP47U20H▲	ACCP47U20EL▲	ACCP47U20IL▲	47	
ACCP48U10▲	ACCP48U10H▲	ACCP48U10EL▲	ACCP48U10IL▲	48	
ACCP48U20▲	ACCP48U20H▲	ACCP48U20EL▲	ACCP48U20IL▲	48	



ACCP40U10L

ACCP40U10EL

▲ Available on request

Data ICT Accessories

Accessories to suit all product ranges in this catalogue

Captive Plug Ring

- An easy-split mechanism allows plug ring to be retro-fitted without cutting the lead.
- Will suit most 10A or 15A single phase moulded SAA plugs.
- Will screw onto typical IP66 sockets similar to the 56 series.
- Clear design makes it easier to view plug for inspection.
- Manufactured from polycarbonate



Part Number	Finish	Sold as	Carton Qty
BRSPR1	Transparent	Single Plug	10

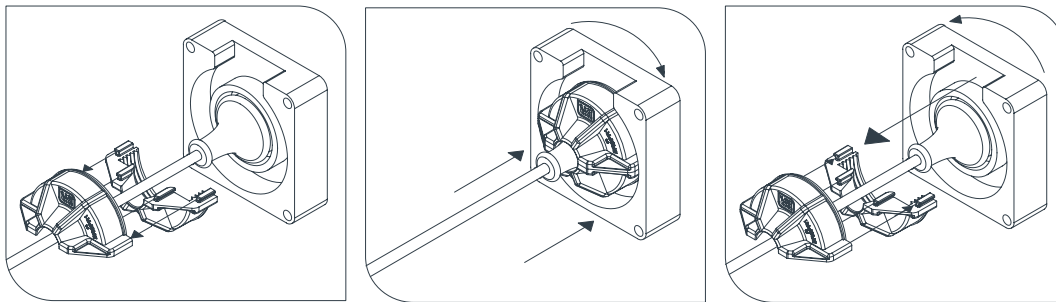

Copper Earth Bars

Installation of a copper earth bar into a data rack or cabinet will allow the active equipment to be grounded, providing protection from static electricity build up.

Part Number	Description	RU	Product Range
ARPEB18U▲	Vertical 25mm x 3mm flat bar with 5.5mm holes	18	Ausrack Plus, CQr Guardian TxD, IP, Field FE & iLINQ
ARPEB24U▲		24	
ARPEB27U▲		27	
ARPEB40U▲		40	
ARPEB42U▲		42	
ARPEB45U		45	
ARPEB47U▲		47	
ARPEB48U▲		48	
ARPEBH1U▲	Horizontal	1	All B&R Data ICT cabinets and frames

ARPEB18U

ARPEB27U

ARPEB40U

ARPEB45U

▲ Available on request

Data ICT Accessories

Accessories to suit all product ranges in this catalogue



Mesh Doors - Single

To maximise airflow all mesh doors consist of 63% or 60% open mesh and include a lockable wing knob and two point locking as standard (keyed to 92268).

Part Number	Description	To suit cabinets & frames		
		RU	Width (mm)	Product Range
ARDM18U06 [▲]	Single Mesh Steel Doors (63% open mesh)	18	600	Ausrack Plus
ARDM18U08 [▲]		18	800	
ARDM24U06 [▲]		24	600	
ARDM24U08		24	800	
ARDM27U06 [▲]		27	600	
ARDM27U08 [▲]		27	800	
ARDM40U06 [▲]		40	600	
ARDM40U08 [▲]		40	800	
ARDM42U06 [▲]		42	600	
ARDM42U08 [▲]		42	800	
ARDM45U06		45	600	
ARDM45U08		45	800	
ARDM47U06 [▲]		47	600	
ARDM47U08 [▲]		47	800	
ARDM48U06 [▲]		48	600	
ARDM48U08 [▲]		48	800	
ATDM45U06 [▲]	Single Mesh Steel Doors (63% open mesh)	45	600	Ausrack TxD
ATDM45U08 [▲]		45	800	
ARDXM12U06	Single Mesh Steel Doors (60% open mesh)	12	600	onyX
ARDXM18U06 [▲]		18	600	
ARDXM22U06 [▲]		22	600	
ARDXM24U06		24	600	
ARDXM32U06 [▲]		32	600	
ARDXM42U06 [▲]		42	600	
ARDXM42U8		42	800	
ARDXM45U06 [▲]		45	600	
ARDXM45U08 [▲]		45	800	
ARDXM47U06 [▲]		47	600	
ARDXM47U08 [▲]	47	800		

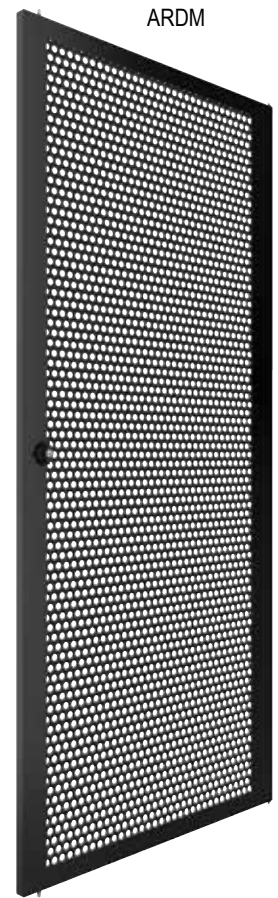

▲ Available on request

For more information contact us on 1300 362 567 | sales@brenclosures.com.au | brenclosures.com.au

Data ICT Accessories

Accessories to suit all product ranges in this catalogue

Mesh Doors - Split

To maximise airflow all mesh doors consist of 63% or 60% open mesh and include a lockable wing knob and two point locking as standard (keyed to 92268).

Part Number	Description	To suit cabinets & frames				
		RU	Width (mm)	Product Range		
ARDD18U06▲	Split Mesh Steel Doors (63% open mesh)	18	600	Ausrack Plus		
ARDD18U08▲		18	800			
ARDD24U06▲		24	600			
ARDD24U08▲		24	800			
ARDD27U06▲		27	600			
ARDD27U08▲		27	800			
ARDD40U06▲		40	600			
ARDD40U08▲		40	800			
ARDD42U06▲		42	600			
ARDD42U08▲		42	800			
ARDD45U06▲		45	600			
ARDD45U08		45	800			
ARDD47U06▲		47	600			
ARDD47U08▲		47	800			
ARDD48U06▲		48	600			
ARDD48U08▲		48	800			
ATDD45U06▲		Split Mesh Steel Doors (63% open mesh)	45		600	Ausrack TxD
ATDD45U08▲			45		800	
ARXDD42U06▲	Split Mesh Steel Doors (60% open mesh)	42	600	onyX		
ARXDD42U08▲		42	800			
ARXDD45U06▲		45	600			
ARXDD45U08▲		45	800			
ARXDD47U06		47	600			
ARXDD47U08▲		47	800			

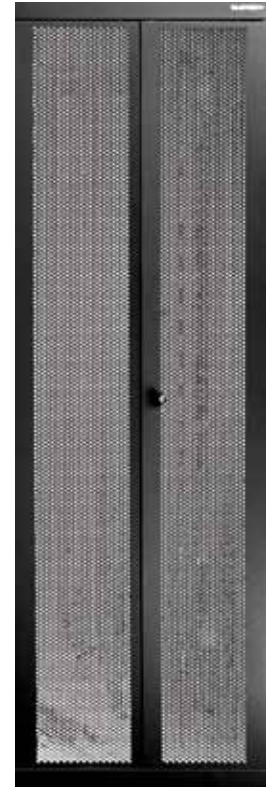

ARDD

Why 60-63% Mesh Doors Will Work For You

Pressure Loss vs Impact Velocity For Various Open Area Perforated Plates
Source: Industrial Perforators Association (1993)

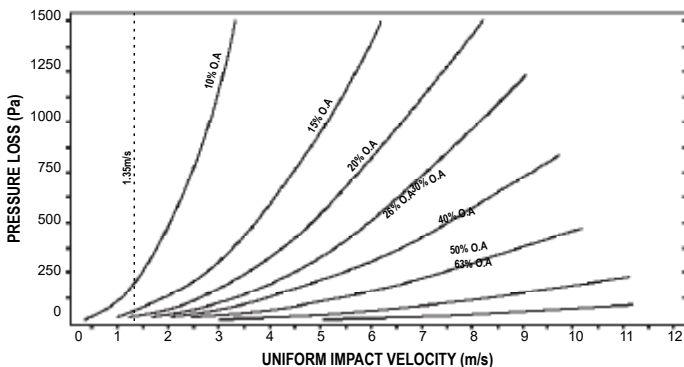

In many applications of mesh doors, the pressure loss through the door is one of the design considerations.

As seen in the graph, B&R's 60-63% mesh doors will have a negligible pressure drop at these velocities. Most computer room air conditioners generate more than 20Pa of pressure, more than enough to overcome the pressure drop at the door in a containment situation.

For example, in a data centre environment, a 15kW heat load in a 45RU cabinet would require 3500m³/h of airflow. This is equivalent of a 1.35m/s impact velocity. In a containment situation with a positive aisle pressure this will be more than the pressure drop of the doors and the equipment will receive sufficient air flow.

With such a negligible restriction to airflow, the higher percentages available in the market have no real advantage. The 60-63% mesh was developed as a cross over point of functional performance and higher security.

▲ Available on request

Data ICT Accessories

Accessories to suit all product ranges in this catalogue



Window Doors

Window doors are available with an acrylic insert panel. An option is also available for venting for airflow. All doors include a lockable wing knob and two point locking as standard. (keyed to 92268) Electronic remote controlled, monitored locking systems, swing handles, custom keying and 3-point locking (ARP3L) are available on request.

To suit cabinets & frames

Part Number	Description	RU	Width (mm)	Range
ARDA18U06▲	Acrylic Window Door	18	600	Ausrack Plus
ARDA18U08▲		18	800	
ARDA24U06▲		24	600	
ARDA24U08▲		24	800	
ARDA27U06▲		27	600	
ARDA27U08▲		27	800	
ARDA40U06▲		40	600	
ARDA40U08▲		40	800	
ARDA42U06▲		42	600	
ARDA42U08▲		42	800	
ARDA45U06▲		45	600	
ARDA45U08		45	800	
ARDA47U06▲		47	600	
ARDA47U08▲		47	800	
ARDA48U06▲		48	600	
ARDA48U08▲		48	800	
ATDA45U06▲	Acrylic Window Door	45	600	Ausrack TxD
ATDA45U08▲		45	800	
ARAV24U06▲	Vented Acrylic Window Door	24	600	Ausrack Plus
ARAV24U08▲		24	800	
ARAV40U06▲		40	600	
ARAV40U08▲		40	800	
ARAV45U06▲		45	600	
ARAV45U08▲		45	800	



ARDA

▲ Available on request

Data ICT Accessories

Accessories to suit all product ranges in this catalogue

Steel Doors

All steel doors include a lockable wing knob and two point locking as standard (keyed to 92268). Electronic remote controlled, monitored locking systems, swing handles, custom keying and 3-point locking (ARP3L) are available on request.

Part Number	Description	To suit cabinets & frames		
		RU	Width (mm)	Range
ARDS18U06▲	Single Steel Door	18	600	Ausrack Plus
ARDS18U08▲		18	800	
ARDS24U06▲		24	600	
ARDS24U08▲		24	800	
ARDS27U06▲		27	600	
ARDS27U08▲		27	800	
ARDS40U06▲		40	600	
ARDS40U08▲		40	800	
ARDS42U06▲		42	600	
ARDS42U08▲		42	800	
ARDS45U06▲		45	600	
ARDS45U08		45	800	
ARDS47U06▲		47	600	
ARDS47U08▲		47	800	
ARDS48U06▲		48	600	
ARDS48U08▲		48	800	
ATDS45U06▲	Single Steel Door	45	600	Ausrack TxD
ATDS45U08▲		45	800	
ARSS24U06▲	Split Steel Doors	24	600	Ausrack Plus
ARSS24U08▲		24	800	
ARSS40U06▲		40	600	
ARSS40U08▲		40	800	
ARSS45U06▲		45	600	
ARSS45U08▲		45	800	



ARDS



ARSS

▲ Available on request

Data ICT Accessories

Accessories to suit all product ranges in this catalogue



Equipment Rails

Equipment rails are L-shaped with mounting on either edge (i.e 19" and 21" can be placed in a 19" or 21" configuration).

Vertical

Part Number	Description	Size	To suit cabinets & frames		
			RU	Width (mm)	Product Range
ARMR12U▲	Pair	19"	12		Ausrack Plus
ARMR24U▲	Pair	19"	24		
ARMR40U▲	Pair	19"	40		
ARMR45U▲	Pair	19"	45		
IPRU11	Rail kit	19"	11	600	Ausrack IP
IPRU11/800▲	Rail kit	19"	11	800	
IPRU15	Rail kit	19"	15	600	
IPRU15/800▲	Rail kit	19"	15	800	
IPRU24	Rail kit	19"	24	600	
IPRU24/800▲	Rail kit	19"	24	800	
IPRU32▲	Rail kit	19"	32	600	
IPRU32/800▲	Rail kit	19"	32	800	
IPRU38▲	Rail kit	19"	38	600	
IPRU38/800▲	Rail kit	19"	38	800	
IPRU42▲	Rail kit	19"	42	600	
IPRU42/800▲	Rail kit	19"	42	800	
ATMR45U619▲	Standard (Pair)	19"	45	600	Ausrack TxD
ATMR45U621▲		21"	45	600	
ATMR45U819▲		19"	45	800	
ATMR45U821▲		21"	45	800	
ATMR45U823▲		23"	45	800	
ATMR45U826▲		26"	45	800	
ATMR45U6A▲	Reversible (Pair)	19"/21"	45	600	Ausrack TxD
ATMR45U8A▲		19"/21"	45	800	
ATMR45U8B▲		19"/23"	45	800	
ATMR45U8C▲		21"/23"	45	800	

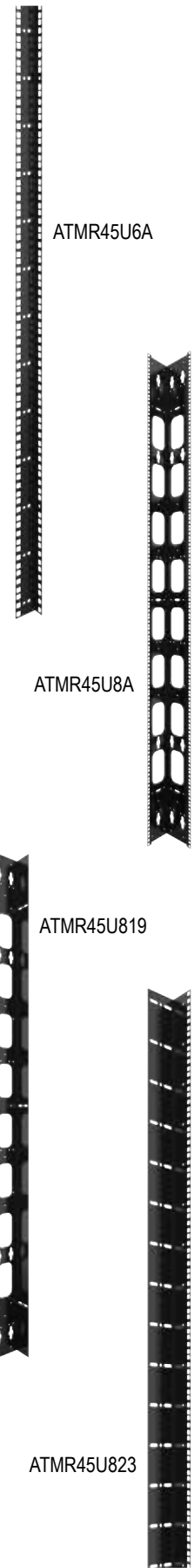

Horizontal

Part Number	Description	To suit cabinets & frames	
		Depth (mm)	Product Range
ARMS06▲	Horizontal support	600	Ausrack Plus
ARMS09▲	Horizontal support	900	
ARMS11▲	Horizontal support	1100	
ATMS09▲	Horizontal support	900	Ausrack TxD
ATMS10▲	Horizontal support	1000	
ATMS12▲	Horizontal support	1200	

Horizontal supports are used to attach short 19" mounting rails.



ARMS

ATMR45U823

▲ Available on request

Data ICT Accessories

Accessories to suit all product ranges in this catalogue

Fans

Both the two and four unit fan kits install into the roof or a bottom plinth. The two unit fan kit can also be fitted into the equipment rails. All fans are supplied with 2m flex and 10A SAA plug.

Part Number	No. of Fans	Description	RU	Enclosure		To Suit Enclosure
				Air flow (cmf)	Noise level (dB)	
ARWX2F	2	Kit - 2 way roof fan with integrated thermostat	-	152	45	Wall onlyX
ARXAF2▲	2	Kit - 2 way roof fan with integrated thermostat	-		48	Floor onlyX
ARPAF2▲	2	High speed, axial fan	1	220	53	Ausrack Plus, Patch, IP, ARPAF2T 2, Field FE & iLINQ
ARPAF2T	2	High speed, axial fan with integrated thermostat	1			
ARPAF2WT▲	2	Whisper quiet fan with integrated thermostat	1	72	29	
ARXAF4U80*▲	4	Kit - 800 deep 4 way fan, roof mounted with integrated thermostat	-	304	62	
ARPAF4*▲	4	High speed, axial fan, roof mounted	-	440	62	Ausrack Plus
ARPAF4T*▲	4	High speed, axial fan, roof mounted with integrated thermostat	-			
ARPAF4WT*▲	4	Whisper quiet fan, roof mounted with integrated thermostat	-	144	35	
ACQRDI4F▲	4	High speed axial door fan	-	296	48	CQr Guardian
ACQRDI8F▲	8	2 sets of high speed axial door fan	-	592	60	
ACQR3AFHF	1	High flow single door fan	-	660	62	

All fans have a 10 Amp 3-pin plug on the power cable.



ARPAF2



ARPAF2WT



ARPAF4



ARPAF4T

▲ Available on request

Data ICT Accessories

Accessories to suit all product ranges in this catalogue



General Accessories

Part Number	Product	To suit enclosure
ARPRK	Heavy duty roller kit 800kg load, adds 10mm to height of cabinet	Ausrack Plus, CQr Guardian & TxD
ARPFK	Adjustable foot kit, pack of 4	Ausrack Plus & CQr Guardian
ATFK▲	Adjustable foot kit, pack of 4	Ausrack TxD
ATIFMK▲	Insulated floor mounting kit with anchors	
ARPSSK▲	Stabiliser kit	
ARPBK	Baying kit, pack of 4 brackets	Ausrack Plus
ARP3L▲	3 point locking kit, suits all doors except split doors	
ARSPIL▲	Side panel internal latch kit, pack of 2	
ARFXBK	Baying kit, pack of 4 brackets	onyX Floor onyX Floor Server
SK3	Door key, keyed to 92268	onyX Floor
ARXSPL	Side panel lock kit, single	onyX
ARSPL	Side panel lock kit, keyed to 92268	Ausrack Plus
ATSPL▲	Side panel lock kit, keyed to 92268	
ATEKDR▲	Earth cable for door. Split doors need two (2)	Ausrack TxD
ATEKSP▲	Earth cable for side panel	
ACQRDSK▲	Door sensor kit, pack of 2	Ausrack CQr Guardian
ES06U▲	6RU swing frame	Ausrack IP
ARBG06▲	Gland plate base - 600W x 600D	
ARBG09▲	Gland plate base - 600W x 900D	
ARBG11▲	Gland plate base - 600W x 1100D	Ausrack Plus
ARCH	Chimney	
ARDELSK▲	Earth lead kit	
ALJK▲	Adjustable joiner kit, 600D - 1200D	Ausrack Patch
ARCN	Cage nuts, screws and washers Pack of 50	
ARSTUD20▲	Rack Studs, pack of 20	All B&R Data ICT products
ARSTUD100▲	Rack Studs, pack of 100	
ARWB1U	Light duty wall mount 19" brackets.	1RU x 500mmW x 200mmD
ARWB2U▲	Suitable when cabinet mounting is not practical and space is limited. One side is hinged to allow patch panels and equipment to be swung out for rear access.	2RU x 500mmW x 200mmD
ARWB4U▲		4RU x 500mmW x 200mmD



ARWB1U &
ARWB2U



ARCN



ARSTUD100

▲ Available on request

For more information contact us on 1300 362 567 | sales@brenclosures.com.au | brenclosures.com.au

Data ICT Accessories

Accessories to suit all product ranges in this catalogue



ARPRK



ARPSK



ARCH



ARPFK



ALJK



ARPBK

Plinths

Provide a fixed base for the cabinet and also a working space underneath the cabinet for the cables.

Part Number	Height (mm)	Width (mm)	Depth (mm)	To suit cabinets & frames
ARXP610▲	100	600	1000	onyX Floor & onyX Floor Server
ARXP62▲	100	600	1200	
ARXP66▲	100	600	600	
ARXP68▲	100	600	800	
ARXP69▲	100	600	960	
ARXP810▲	100	800	1000	
ARXP82▲	100	800	1200	
ARXP88▲	100	800	800	
ARXP89▲	100	800	960	



ARXP88
(set up without fixings)



ARXP88
(parts and fixings)

▲ Available on request

Ausrack Power Rails & Intelligent PDU's

Power distribution products



- Suitable for distribution of 10A and 15A circuits to a number of 10A SAA outlets or IEC outlets inside an enclosure.
- Horizontal and vertical power rails used for power distribution inside cabinets and enclosures.
- Also available with surge protection options.
- Suitable for use in all Ausrack cabinets.
- Custom power rails are available on request.

Comes standard with:

- Power rail
- 2m lead
- Mounting brackets
- All fixing hardware



ARPRV101015

ORDER GUIDE - STANDARD

Part Number	Orientation	RU	Description	Product Range
ARPRH61010	Horizontal	1	6 x 10A SAA Outlet 10A SAA Plug	All B&R Data ICT cabinets and frames
ARPRH61015		1	6 x 10A SAA Outlet 15A SAA Plug	
ARPRH101010		2	10 x 10A SAA Outlet 10A SAA Plug	
ARPRH101015		2	10 x 10A SAA Outlet 15A SAA Plug	
ARPRV61010	Vertical	10	6 x 10A SAA Outlet 10A SAA Plug	Ausrack Plus, CQr Guardian, TxD, Patch, IP, Field FE & iLINQ
ARPRV61015*		10	6 x 10A SAA Outlet 15A SAA Plug	
ARPRV101010		16	10 x 10A SAA Outlet 10A SAA Plug	
ARPRV101015		16	10 x 10A SAA Outlet 15A SAA Plug	
ARPRV201010		28	20 x 10A SAA Outlet 10A SAA Plug	
ARPRV201015		28	20 x 10A SAA Outlet 15A SAA Plug	
ARPRV10C13C14		16	10 x 10A IEC320-C13 Outlet, 10A IEC320-C14 Plug	
ARPRV10C13C20		16	10 x 10A IEC320-C13 Outlet, 16A IEC320-C20 Plug	



ARPRH61015



ARPRV61015



ARPRH101010



ARPRH61010



ARPRH101015



ARPRV10C13C14

▲ Available on request

Ausrack Power Rails & Intelligent PDU's

Power distribution products

ORDER GUIDE - SURGE PROTECTION

Part Number	Orientation	RU	Description	Product Range
ARPRHS61010	Horizontal	1	6 x 10A SAA Outlet, 10A Captive Plug	All B&R Data ICT cabinets and frames
ARPRHS61015 [▲]		1	6 x 10A SAA Outlet, 15A Captive Plug	
ARPRVS101015	Vertical	17	10 x 10A SAA Outlet, 15A Captive Plug	Ausrack Plus, CQr Guardian, TxD, Patch, IP, Field FE & iLINQ



Intelligent PDU's and Customised Power Rail Solutions

Intelligent PDUs, or iPDUs, are a small but essential part of the data centre energy supply chain. An Intelligent PDU works like a brain within the rack, providing comprehensive, accurate energy measurement data needed to reduce waste, enhance operations, and prove the business case for optimisation.

The Intelligent Power Distribution Unit sits within the rack continually looking for threats from electrical circuit overloads, and any physical or environmental conditions which might place critical IT computing loads at risk.

B&R is able to provide a range of Intelligent PDU's to suit any Data ICT project application. Speak to one of our team about your requirements today.

PDU Brackets

Allows for PDU's to be installed to the rack using many different configurations.

To suit cabinets & frames

Part Number	Description	Width (mm)	Depth (mm)	Product Range
ARXPRBK [▲]	Single PDU	800	-	onyX Floor & onyX Floor Server <i>(with cable management removed)</i>
ARXPDUBK45U [▲]	Single PDU	800	-	onyX Floor & onyX Floor Server <i>(with cable management removed)</i>
ARPDUBRK600 [▲]	Single PDU	600	-	Ausrack Plus
ARPDUBRK800 [▲]	Double PDU	800	-	
ATPDUBRK600 [▲]	Single PDU	600	-	Ausrack TxD
ATPDUBRK800 [▲]	Double PDU	800	-	

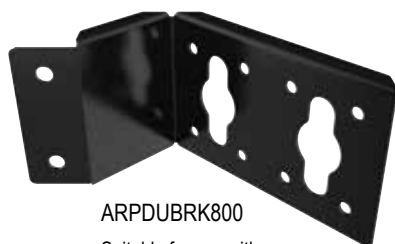

[▲] Available on request

Data ICT Accessories

Accessories to suit all product ranges in this catalogue



Shelves

Providing a stable platform for other miscellaneous gear, shelving mounts off the 19" rack rails. All shelves are vented to allow vertical airflow.

Part Number	Description	RU	Depth (mm)	Load Rating (kg)	Suit Cabinet Depth	Product Range
ARTF450	Telescopic, full extension	1	450	20	600mm deep	All B&R Data ICT cabinets and frames
ARTF750		1	750	20	900mm deep	onyX Floor, onyX Server, Ausrack Plus, CQr Guardian, TxD, Field FE & iLINQ
ARTF950▲		1	950	20	1100mm deep	
ARTH450▲	Telescopic, half extension, locking	1	450	40	600mm deep	All B&R Data ICT cabinets and frames
ARTH750▲		1	750	40	900mm deep	onyX Floor, onyX Server, Ausrack Plus, CQr Guardian, TxD, Field FE & iLINQ
ARTH950▲		1	950	40	1100mm deep	
ARC360	Cantilever	2	360	10	–	All B&R Data ICT cabinets and frames *excluding all ARIP <400mm deep
ARC210		2	210	10	–	All B&R Data ICT cabinets and frames
ARPCS150▲		2	150	10	–	
ARPCS250▲		2	250	10	–	
ARPCS350▲		2	350	10	–	
ARPCS450▲		2	450	10	–	
ARWX450CS		2	450	10	–	onyX
ARXKBC350	1	350	10	600		
ARXKBC550▲	Keyboard shelf	1	550	10	800	
ARKBC▲	Keyboard pivot tray accessory*	2	–	–	–	All B&R Data ICT cabinets and frames

* Requires half extension telescopic shelf to mount.

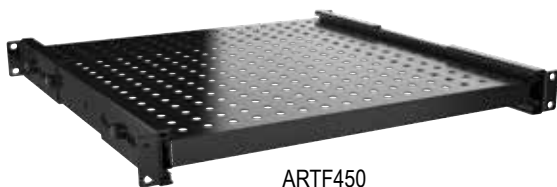

ARTF450

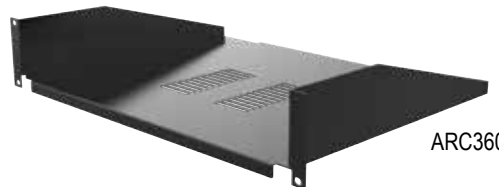

ARC360



ARKBC



ARPCS250
shown from rear



ARPCS450

▲ Available on request

Data ICT Accessories

Accessories to suit all product ranges in this catalogue

Shelves

Providing a stable platform for other miscellaneous gear, shelving mounts off the 19" rack rails. All shelves are vented to allow vertical airflow.

Part Number	Description	RU	Depth (mm)	Load Rating (kg)	Suit Cabinet Depth (mm)	Product Range
ARXFL350		1	350	20	600	onyX
ARXFL550		1	550	20	800	
ARXFL710		1	710	20	1000	
ARWX450FS		1	450	20	450	
ARWX600FS▲		1	600	20	600	
ARPFL600		Fixed, light duty	1	450	50	
ARPFL800	1		650	50	800	onyX Floor, onyX Server, Ausrack Plus, CQr Guardian, TxD, Field FE & iLINQ
ARPFL900	1		750	50	900	onyX Floor, onyX Server, Ausrack Plus, CQr Guardian, TxD & iLINQ
ARPFL1000	1		850	50	1000	
ARPFL1100	1		950	50	1100	
ARPFL1200	1		1050	50	1200	
ARPFH600	Fixed, heavy duty		1	450	160	600
ARPFH800▲		1	650	160	800	onyX Floor, onyX Server, Ausrack Plus, CQr Guardian, TxD, Field FE & iLINQ
ARPFH900▲		1	750	160	900	onyX Floor, onyX Server, Ausrack Plus, CQr Guardian, TxD & iLINQ
ARPFH1000▲		1	850	160	1000	
ARPFH1100		1	950	160	1100	
ARPFH1200		1	1050	160	1200	

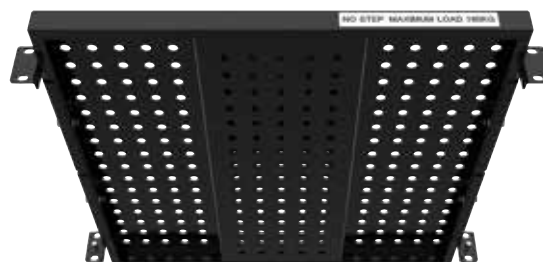
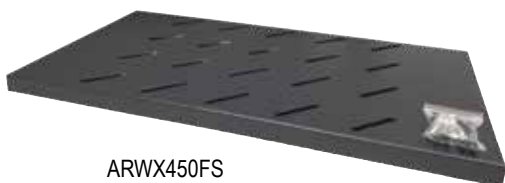
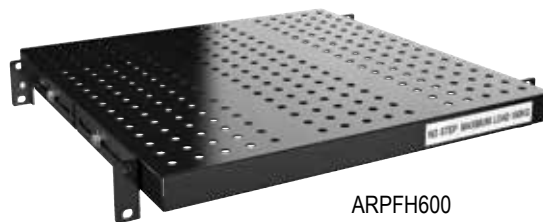
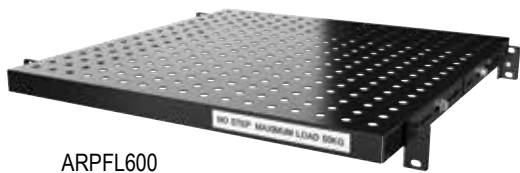

▲ Available on request

Data ICT Accessories

Accessories to suit all product ranges in this catalogue



Side Cladding (Panels)

Side panels include venting and are easy-to-fit using locating pins and slam latches. They can be locked into the frame for added security using either an external key lock kit (ARSPL) or an internal latch kit (ARSPIL).

Privacy Panels are a secure method of providing security to a single cabinet when cabinets are bayed together, by using either a non-removable panel, or a removable set of panels. These panels can also segregate air to ensure no cross cabinet mixing.

Part Number		To suit cabinets & frames		
Side Panels	Privacy Panels	RU	Depth (mm)	Product Range
ARP18U06▲		18	600	Ausrack Plus
ARP18U08▲		18	800	
ARP18U09▲		18	900	
ARP18U10▲		18	1000	
ARP18U11▲		18	1100	
ARP18U12▲		18	1200	
ARP24U06▲		24	600	Ausrack Plus
ARP24U08		24	800	
ARP24U09▲		24	900	
ARP24U10▲		24	1000	
ARP24U11▲		24	1100	
ARP24U12▲		24	1200	
ARP27U06▲		27	600	Ausrack Plus
ARP27U08▲		27	800	
ARP27U09▲		27	900	
ARP27U10▲		27	1000	
ARP27U11▲		27	1100	
ARP27U12▲		27	1200	
ARP40U06▲	ARPP40U06▲	40	600	Ausrack Plus
ARP40U08▲	ARPP40U08▲	40	800	
ARP40U09	ARPP40U09▲	40	900	
ARP40U10▲	ARPP40U10▲	40	1000	
ARP40U11▲	ARPP40U11▲	40	1100	
ARP40U12▲	ARPP40U12▲	40	1200	
ARP42U06▲	ARPP42U06▲	42	600	Ausrack Plus
ARP42U08▲	ARPP42U08▲	42	800	
ARP42U09▲	ARPP42U09▲	42	900	
ARP42U10	ARPP42U10▲	42	1000	
ARP42U11▲	ARPP42U11▲	42	1100	
ARP42U12▲	ARPP42U12▲	42	1200	
ARP45U06▲	ARPP45U06▲	45	600	Ausrack Plus
ARP45U08▲	ARPP45U08▲	45	800	
ARP45U09	ARPP45U09▲	45	900	
ARP45U10	ARPP45U10▲	45	1000	
ARP45U11	ARPP45U11▲	45	1100	
ARP45U12	ARPP45U12	45	1200	
ARP47U06▲	ARPP47U06▲	47	600	Ausrack Plus
ARP47U08▲	ARPP47U08▲	47	800	
ARP47U09▲	ARPP47U09▲	47	900	
ARP47U10▲	ARPP47U10▲	47	1000	
ARP47U11▲	ARPP47U11▲	47	1100	
ARP47U12▲	ARPP47U12▲	47	1200	
ARP48U06▲	ARPP48U06▲	48	600	Ausrack Plus
ARP48U08▲	ARPP48U08▲	48	800	
ARP48U09▲	ARPP48U09▲	48	900	
ARP48U10▲	ARPP48U10▲	48	1000	
ARP48U11▲	ARPP48U11▲	48	1100	
ARP48U12▲	ARPP48U12▲	48	1200	



ARP42U08

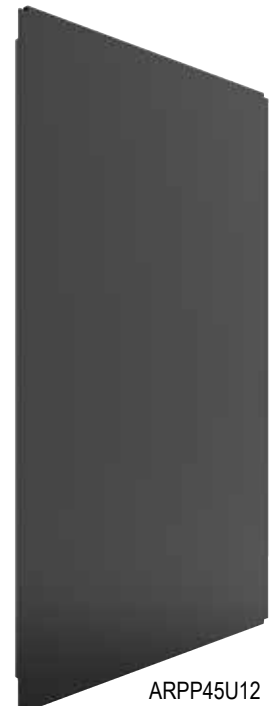

ARPP45U12

▲ Available on request

Data ICT Accessories

Accessories to suit all product ranges in this catalogue

Side Panels

Include venting and are easy to fit using locating pins and flush mounted slam latches. They can be locked using an external lock kit (ATSPL). Cabinets can be bayed together with or without side panels fitted.

Part Number	To suit Ausrack TxD cabinets	
	RU	Depth (mm)
ATSP45U09▲	45	900
ATSP45U10▲	45	1000
ATSP45U12▲	45	1200

Top Covers

Used to enclose the frame's top plinth section. Raised top covers feature ventilation for airflow and can be used in conjunction with fans

Part Number	Description	To suit cabinets & frames		
		Width (mm)	Depth (mm)	Product Range
ATTF609▲	Flat	600	900	Ausrack TxD
ATTF610▲		600	1000	
ATTF612▲		600	1200	
ATTF809▲		800	900	
ATTF810▲		800	1000	
ATTF812▲		800	1200	
ARTF606▲	Flat	600	600	Ausrack Plus
ARTF609▲		600	900	
ARTF610▲		600	1000	
ARTF611▲		600	1100	
ARTF612▲		600	1200	
ARTF808▲		800	800	
ARTF809▲		800	900	
ARTF811▲		800	1100	
ARTR606▲	Raised	600	600	Ausrack Plus
ARTR609▲		600	900	
ARTR610▲		600	1000	
ARTR611▲		600	1100	
ARTR612▲		600	1200	
ARTR809▲		800	900	
ARTR810▲		800	1000	
ARTR811▲		800	1100	
ARTR812▲	800	1200		



ARTF808

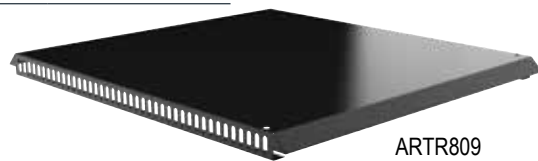

ARTR809

ARTR809 - shown from underneath.



▲ Available on request