

WID01

ANTICONDENSATION HEATERS

Characteristics	M.U.	TX-WID01ZX0X
Heating capacity*	W	10
Power supply	V ~ Hz	110 - 250 V AC/DC
Dimensions HxWxD	mm	61x50x25
Max. current	A	0,8
Heating element	-	PTC self regulated
Electrical connection	-	cable L = 0,3 m
Protection class IEC	-	I
Protection level EN60529	-	IP54
Radiator	-	die-cast aluminium
Mounting on clip for DIN bar	mm	35
Weight	Kg	0,1
Conformity	-	CE

Accessories/Options	
0-60°C thermostat, NC 10A	TX-AAWTC10
10-60°C thermostat, 10A change-over contactor	TX-AAWTS10
RH 35-95% humidistat, 5A change-over contactor	TX-AAWHS10

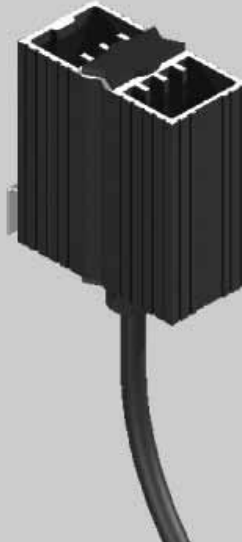

Dimensions

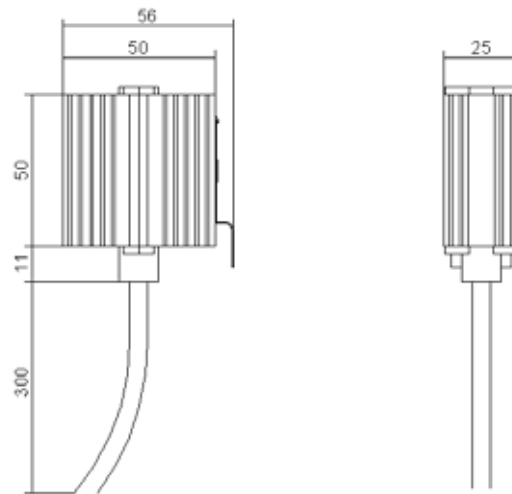

Composition of the supply

- Ready-to-install heater
- Instructions for installation and use
- DIN bar fixing accessories